

## 2' Tension Fabric Displays: Assembly Guide

### Included Pieces

1. Top Corner Poles (x2)
2. Left Side Poles
3. Right Side Poles
4. Bottom Corner Poles (x2)
5. Top & Bottom Center Poles (x2)
6. Fabric
7. Middle Pole
8. Feet (x2)
9. Plastic Hinge Connector

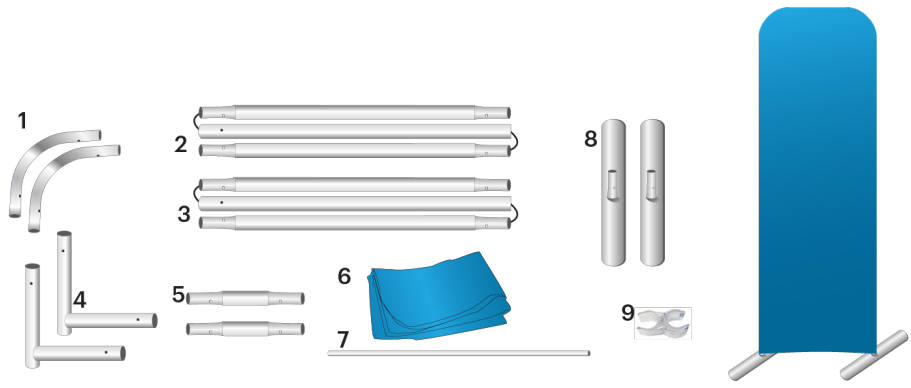

### Instructions

**STEP 1:** Remove all pieces from your included carrying case and place on a clean, flat surface. Make sure you have all the pieces listed above.

**STEP 2:** Assemble all the poles by connecting the corresponding numbers together while pressing the snap button as shown below.

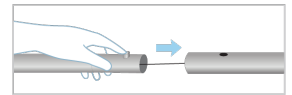
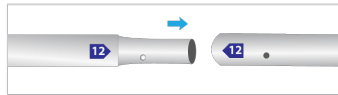

**STEP 3:** Continue to connect the poles as illustrated in the image below.

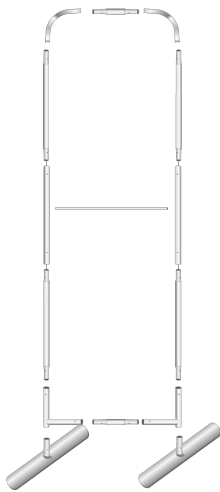

**STEP 4:** Snap the completed frame into the feet, then drape the fabric over the connected poles.

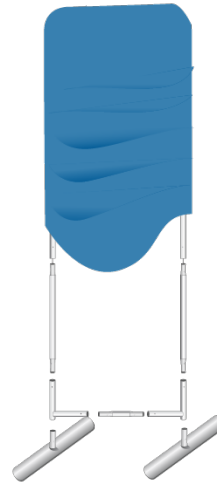

### Using more than 1 display?

To connect 2 displays together, use the plastic hinge connector. Just clip it on to a side pole and connect it to the other display's side pole.

### Storage & Care

To store your tension fabric display, put all the product pieces into the carrying case and place in a cool and dry indoor location. You can machine wash the fabric on your gentle cycle using mild detergent. We recommend tumble drying with no heat. Don't dry clean or iron.

# 3' Tension Fabric Displays: Assembly Guide

## Included Pieces

1. Top Corner Poles (x2)
2. Left Side Poles
3. Right Side Poles
4. Bottom Corner Poles (x2)
5. Top & Bottom Middle Poles (x2)
6. Fabric
7. Middle Pole (2 pieces)
8. Feet (x2)
9. Plastic Hinge Connector

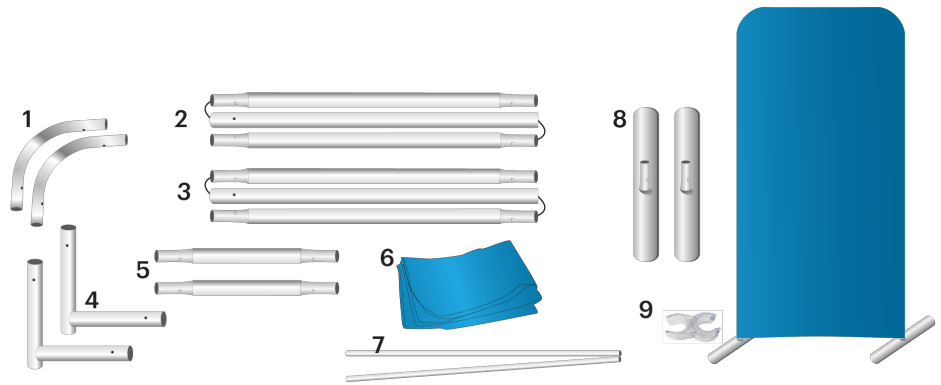

## Instructions

**STEP 1:** Remove all pieces from your included carrying case and place on a clean, flat surface. Make sure you have all the pieces listed above.

**STEP 2:** Assemble all the poles by connecting the corresponding numbers together while pressing the snap button as shown below.

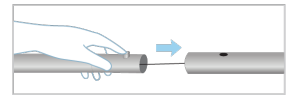
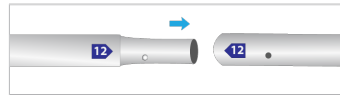

**STEP 3:** Continue to connect the poles as illustrated in the image below.

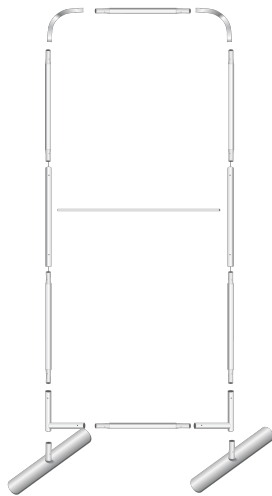

**STEP 4:** Snap the completed frame into the feet, then drape the fabric over the connected poles.

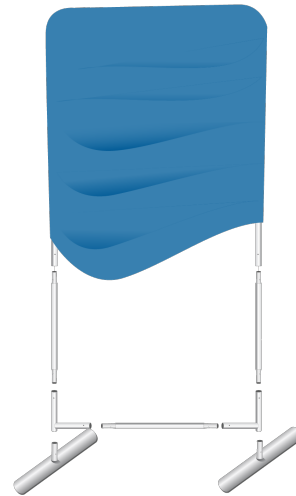

## Using more than 1 display?

To connect 2 displays together, use the plastic hinge connector. Just clip it on to a side pole and connect it to the other display's side pole.

## Storage & Care

To store your tension fabric display, put all the product pieces into the carrying case and place in a cool and dry indoor location. You can machine wash the fabric on your gentle cycle using mild detergent. We recommend tumble drying with no heat. Don't dry clean or iron.

# 8' Tension Fabric Displays: Assembly Guide

## Included Pieces

1. Top Corner Poles (x2)
2. Top Pole
3. Bottom Pole
4. Bottom Corner Poles (x2)
5. Left & Right Poles (x2)
6. Fabric
7. Vertical Middle Pole (4 pieces)
8. Feet (x2)
9. Plastic Hinge Connector

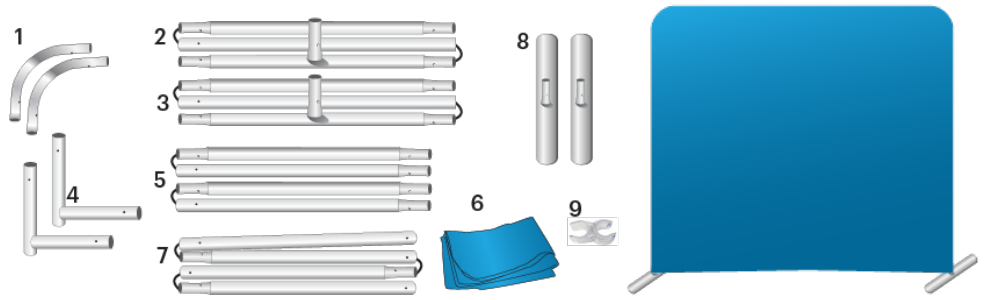

## Instructions

**STEP 1:** Remove all pieces from your included carrying case and place on a clean, flat surface. Make sure you have all the pieces listed above.

**STEP 2:** Assemble all the poles by connecting the corresponding numbers together while pressing the snap button as shown below.

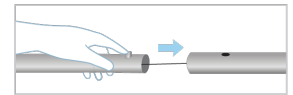
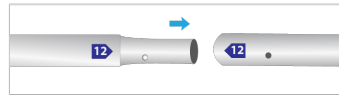

**STEP 3:** Continue to connect the poles as illustrated in the image below.

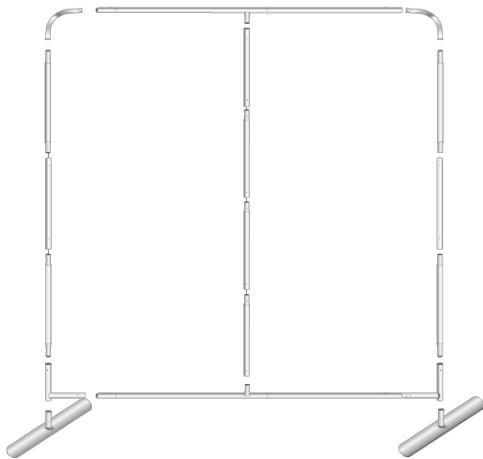

**STEP 4:** Snap the completed frame into the feet, then drape the fabric over the connected poles.

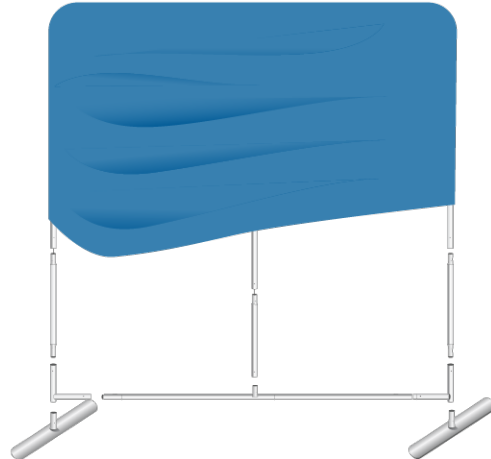

## Using more than 1 display?

To connect 2 displays together, use the plastic hinge connector. Just clip it on to a side pole and connect it to the other display's side pole.

## Storage & Care

To store your tension fabric display, put all the product pieces into the carrying case and place in a cool and dry indoor location. You can machine wash the fabric on your gentle cycle using mild detergent. We recommend tumble drying with no heat. Don't dry clean or iron.

# 10' Tension Fabric Displays: Assembly Guide

## Included Pieces

1. Top Corner Poles (x2)
2. Top Pole (4 pieces)
3. Bottom Pole (4 pieces)
4. Bottom Corner Poles (x2)
5. Fabric
6. Plastic Hinge Connector
7. Feet (x2)
8. Left Pole (3 pieces)
9. Right Pole (3 pieces)
10. Vertical Middle Pole (4 pieces)

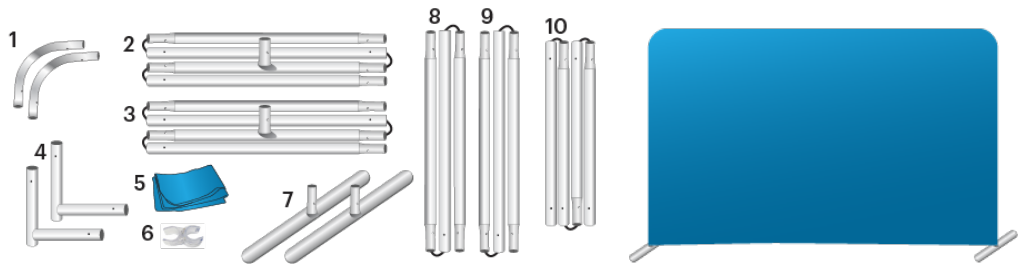

## Instructions

**STEP 1:** Remove all pieces from your included carrying case and place on a clean, flat surface. Make sure you have all the pieces listed above.

**STEP 2:** Assemble all the poles by connecting the corresponding numbers together while pressing the snap button as shown below.

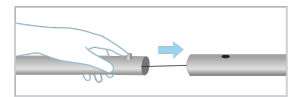
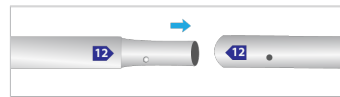

**STEP 3:** Continue to connect the poles as illustrated in the image below.

**STEP 4:** Snap the completed frame into the feet, then drape the fabric over the connected poles.

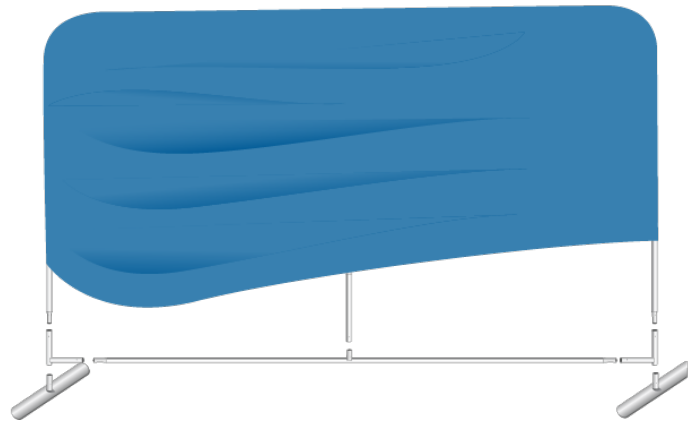
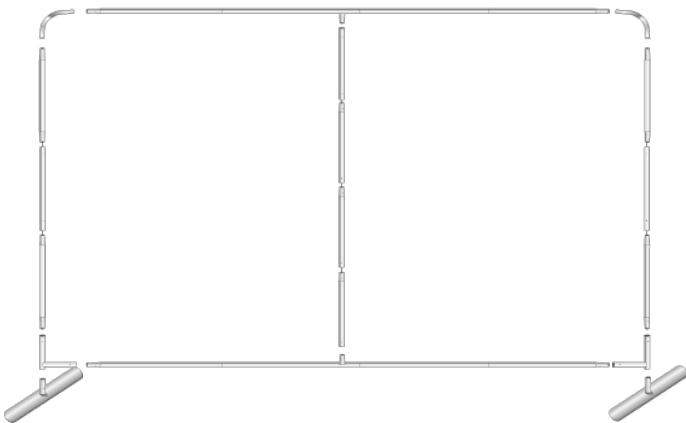

## Using more than 1 display?

To connect 2 displays together, use the plastic hinge connector. Just clip it on to a side pole and connect it to the other display's side pole.

## Storage & Care

To store your tension fabric display, put all the product pieces into the carrying case and place in a cool and dry indoor location. You can machine wash the fabric on your gentle cycle using mild detergent. We recommend tumble drying with no heat. Don't dry clean or iron.